

FAGERHULT

SE - 566 80 Habo

Evolume 1

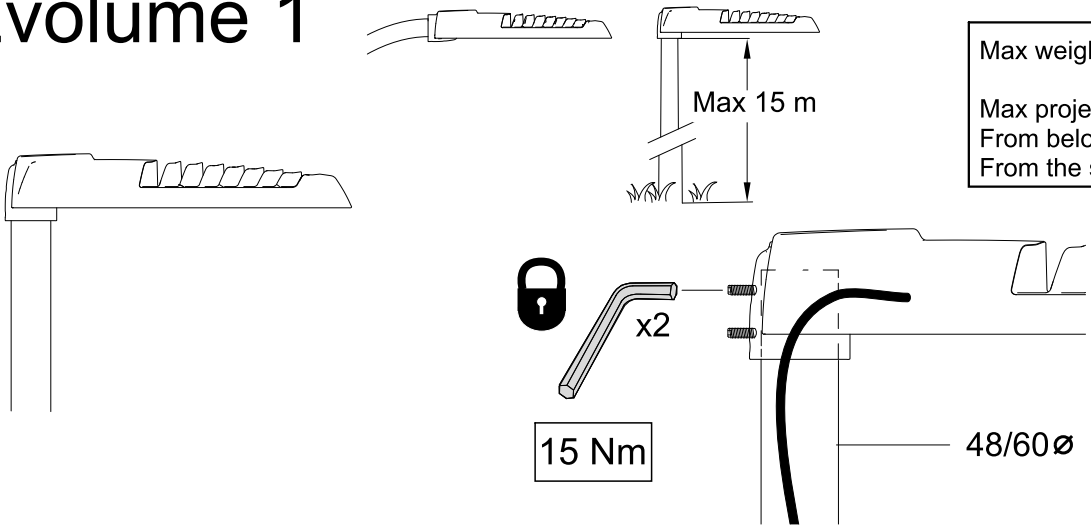
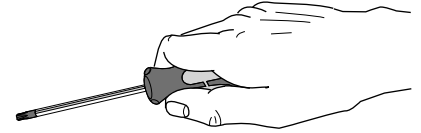

Max weight 7 kg

Max projected area
From below 0,158m²
From the side 0,035m²

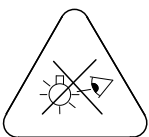
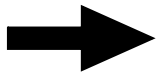
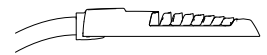
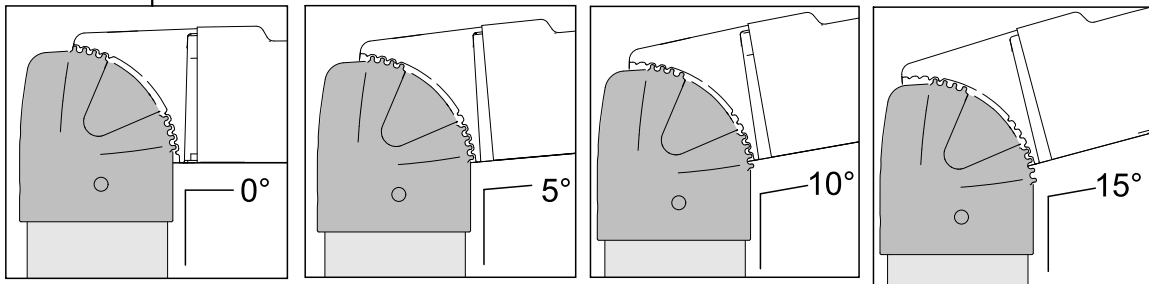
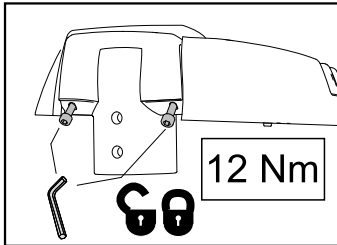

- (S)** Armaturen bör placeras så att långvarigt tittande direkt in i armaturen inte förväntas på ett avstånd närmre än 1 m.
- (GB)** The luminaire should be positioned so that prolonged staring into the luminaire at a distance closer than 1 m is not expected.

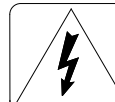

- Ljuskällan ska enbart bytas ut av tillverkaren eller hans utsedda person.
- The light source shall only be replaced by the manufacturer or his designated person.

- (S)** Det är lämpligt att denna information överlämnas till användaren av anläggningen.
- (GB)** It is appropriate that this information is passed on to the users of the installation.
- (D)** Diese Informationen sind für den Benutzer der Anlage vorgesehen.
- (SF)** Nämä ohjeet tulee säilyttää ja luovuttaa kiinteistön käyttäjälle.

Class II

- (S)** Om armaturens kabel skulle skadas skall den bytas av tillverkaren, eller av tillverkaren utsedd person.
- (GB)** If the cord of this luminaire is damaged, it shall exclusively be replaced by the manufacturer, or by the manufacturer designated person.

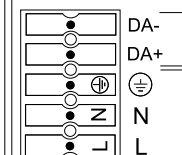

- (S)** Grundläggande isolering mellan nät och styr ledning.
- (GB)** Basic insulation between mains and control wiring.

