

e-Sense Connect

Manual for installation in teaching rooms

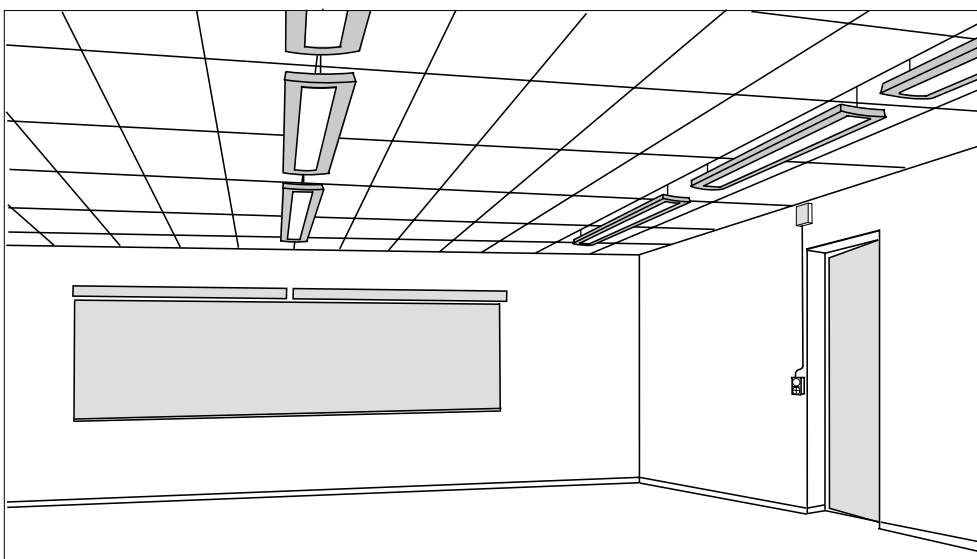

FAGERHULT

Contents

Introduction to wireless communication with e-Sense Connect	3
Components	4–5
Installation example	6
System structure, grouping	7
Positioning of control unit and maneuver unit	8
Connection of control unit and maneuver unit	9
Interface for control with impulse switch	10
User functions	11–12
System functions, basic settings	13–15
System programming	16–21
User function	22
e-Sense Connect RF unit used as a relay	23
Technical information	24–25
Special functions	26

This information applies for e-Sense Connect version 3.

Introduction to wireless communication with e-Sense Connect

Wireless communication

In wireless e-Sense Connect, three units communicate wirelessly with one another. There is continuous wireless communication between RF units in luminaires and the central control unit and, during programming, with the remote control as well. Central to the system is a control unit which is the link between the luminaires and the control functions. The control unit transmits above the 2.4 GHz frequency band, using an advanced technology which it shares with the RF units in the luminaires. In brief, it is a smart radio which adjusts to its environment to deliver best performance and reliability, without interfering with any other wireless devices. If other devices, e.g., wireless routers for IT networks, communicate on the same bandwidth, then the e-Sense Connect signal moves to a less populated frequency. The power used in communicating between the units is minimal and cannot be likened to the power consumption of mobile phones. The relative proximity of the units to each other and their distance from people means that communication is like that in a wireless IT network. All the wireless communication units have an integrated antenna which does not impact on their physical design or result in any special space requirements.

In addition to wireless radio communication with the luminaires, the control unit is also permanently connected to a maneuver unit adapted to user requirements. This connection is of SELV extra-low voltage type.



What does RF control mean?

There is nothing new about sending information wirelessly, and its ongoing development means that we can use it in more environments than before. Ordinary lighting in schools and offices can now be effectively controlled at reasonable cost and within a short time without making major changes to the installation. There are various frequencies currently available for sending information wirelessly without a licence. 833 MHz can be used for control of more straightforward type, such as wireless remote control for home use or car keys. The frequency used by e-Sense Connect is 2.4 GHz, which is the same as that used in, e.g., wireless IT networks, known as WLAN. It allows signal strength to be set to the minimum for communication between an RF unit in a luminaire and the control unit.

The output signal of a mobile phone is approximately 10 to 100 times stronger than that used by e-Sense Connect. The signal between an RF unit and a control unit will just cover a distance of over 100 metres, provided there are no obstacles. So, if there are concrete walls in the way, the distance may be reduced to around 30 metres. This is because the system is after all intended for use where the RF unit and control unit are located in the same room. The design of luminaires can also have an effect on the distance, but 30 metres can always be taken as definite. In a single system, at least 50 RF units can communicate with a control unit. To keep an installation manageable, the number of luminaires associated with one control unit should be limited to those installed in a given room. It is better to distribute luminaires across several control units, as the system's potential for grouping is flexible but relatively limited.

Components

e-Sense Connect lighting control system has been developed for professional installation in rooms intended for teaching or working, such as a school or an office. The system's functions are adapted to ensure optimum energy-saving, as well as light quality for the user.

The installation and user functions are focused on simplicity and intuitive use of a lighting installation in teaching rooms. The technology behind the system is the most sophisticated to have been developed for lighting control to date, facilitating installation and maintenance as well as future changes. e-Sense Connect consists of a number of active and passive units, making up a complete system.

RF unit

Every luminaire has an RF unit that controls and regulates the ballast for the light source. The radio communication is duplex and based on the latest technology for secure and optimal transfer of information. The luminaires can also be fitted with a sensor unit that has several functions. This sensor is located in a cell in the louvre or in the luminaire body.



86302

Sensor for occupancy detection

The sensor has a PIR (Passive InfraRed) module which detects infrared light in motion, or, to put it more simply, a warm body in motion. Information from the detection system is supplemented by a time delay so that periods of non-detection (e.g., sitting still) do not adversely affect the system, by switching off the light, for example.

Sensor for daylight control

There is an active system in e-Sense Connect that adjusts the amount of artificial light (luminaire light) to the amount of incident daylight. One or more daylight sensors in the luminaires combine to ensure even and balanced light intensity throughout the entire room. A normal light level is approximately 500 lux on the work surface and, thanks to the automatic setting feature, it is easy to start the system. With several sensors, an active and dynamic response to incident daylight is achieved. Depending on whether the sun is high or low in the sky, the system makes zonal adjustments to compensate for the amount of light. By taking this approach it is possible to ensure both the optimal light level is achieved while achieving major energy savings at certain times throughout the year.



Ten Line with sensor.

Control unit

Central to the system is a control unit which is the link between the luminaires and the control functions. The control unit transmits on the 2.4 GHz ISM band. The user interface is connected to the control unit by low voltage cabling. The connection can be made using either surface-mounted or recessed installation. The control unit contains DIP switches for configuring basic settings, for more information see the manual at Fagerhult's webpage.



86300

Maneuver unit

e-Sense Connect has been developed for control that uses standard modules available from switch manufacturers. A rotary potentiometer for 1–10 V plus pushbutton functions for mains or extra-low voltage systems, with or without LED indicator, can be used. For the various possible designs, see page 11.



Example of a maneuver unit – Elko.



OPUS 66 for Denmark.

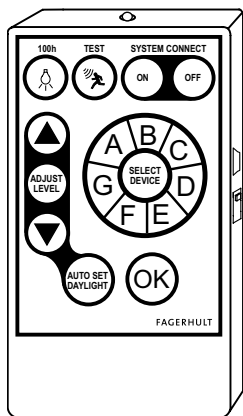

USB Port. For future update of the system.

ON/OFF for battery circuit. To avoid unnecessary battery usage always disconnect the battery circuit. Switch in UP position = battery circuit enabled. Switch in DOWN position = battery circuit disabled.

RF remote control programming tool

The communication in a system takes place between the luminaires’ RF units and the control unit. The RF remote control is used as a temporary tool for programming the system. A few basic functions can create a very energy-efficient solution which provides lighting comfort for the user. The remote control uses RF signals rather than IR signals, which means that you only need to direct it towards the luminaires when first programming the groupings.

Note: Connecting or disconnecting of the battery power is done with a switch located on the right side of the RF remote. When the RF remote is not used, always disconnect the battery circuit.

Switch in UP position = battery circuit enabled.

Switch in DOWN position = battery circuit disabled.



86301

Replacing the potentiometer with an impulse switch for control

Some installations require a more robust solution than a potentiometer, and to enable control from more than one place.

Use a standard impulse switch for this function. Switch 6 in the Control unit will activate this.

See page 25 for connection and more information.

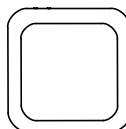

Impulstryckknapp

Installation example

Teaching room

e-Sense Connect has been developed and tailored for installation in new or refurbished classrooms. The simplicity of the solution is grounded in functionality and the ease and speed with which installation can be achieved, driven by our insight into the processes of installation and needs within the space. Slide projectors are increasingly a standard aid used in teaching. The picture quality depends on the extent to which the ambient lighting can be adjusted. Having the lighting full on is not always the best option.

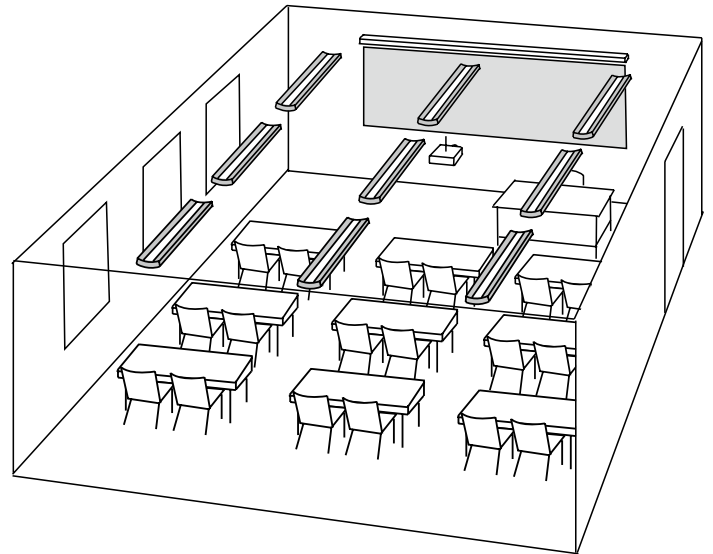

Office

Large, open office areas are ideal for a e-Sense Connect system. Unlike teaching rooms, the option of automatic switch-on of the lighting can be retained, while adding daylight controls increases both the energy efficiency and flexibility of the space. The zonal distribution of the luminaires ensures you will always get the right amount of light, even when some distance away from incident daylight.

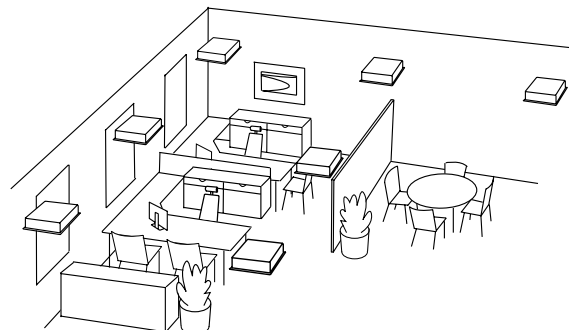

Conference room

As in a classroom, the projector scenario may apply if images are displayed using a projector, or, with increasing frequency, on widescreen LED TVs. During long sessions, good contrast for slideshows is important. It cannot be assumed that the last person leaving will turn off the lights, so sensors are a must to prevent wasting energy. The choice of luminaires for conference rooms is often comparable in other respects to that for offices and teaching rooms, and the same principle applies to e-Sense Connect.

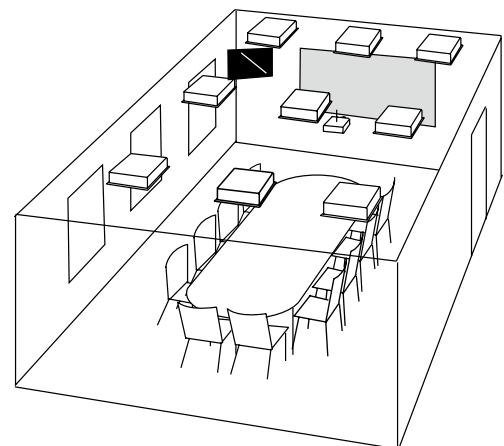

System structure, grouping

Example of a larger teaching room

Wireless e-Sense Connect's control unit can control an unlimited number of RF units and its the physical area which offers the only limitations. If daylight control is used, the three regulated zones are always in the vicinity of incident daylight, and this will restrict the size of the system.

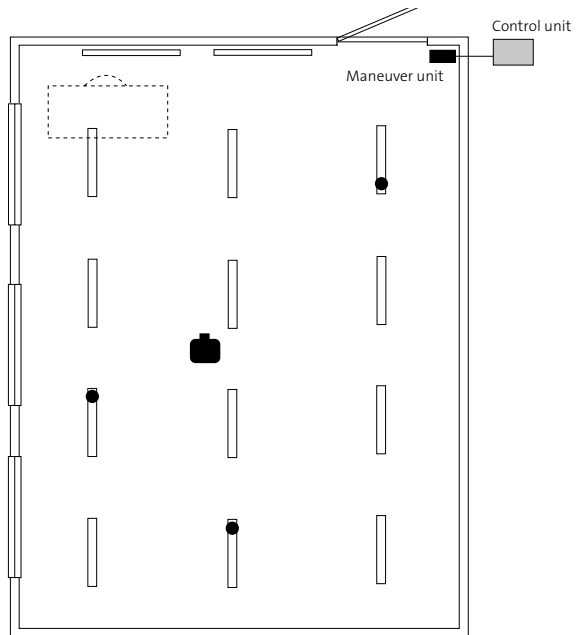

e-Sense Connect – basic principles and system structure

The basis of e-Sense Connect is that a relatively large number of luminaires, each with an integrated RF unit, communicate with a central control unit. While these luminaires can act independently they are positioned by assigning them to one or more groups. Most groups have a predetermined function and are also directly connected to the maneuver unit used in the system. Groups A, B and C are always reserved for ceiling lighting, located at varying distances from the incident daylight. Group D is reserved for board lighting and works independently of the system, except that the light is switched off along with the rest of the lighting after the last detected occupancy of the room. The programming tool is an RF remote control which is used for quick programming of the lighting in a given installation. You can reprogram as often as required, and no information is lost in the event of power failure or extended periods without power supply.

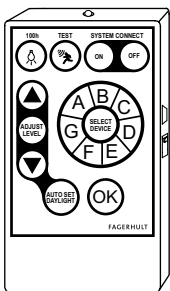
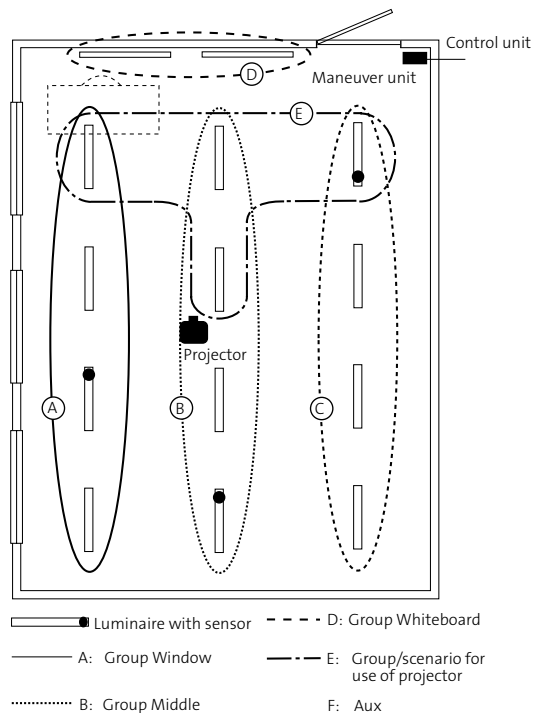

Positioning of control unit and maneuver unit

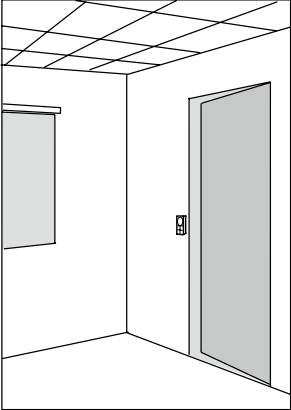

The best position for the maneuver unit is next to the door and connected with the control unit. The maneuver unit must not be connected to 230 V. For control from two locations, see the information on page 13.

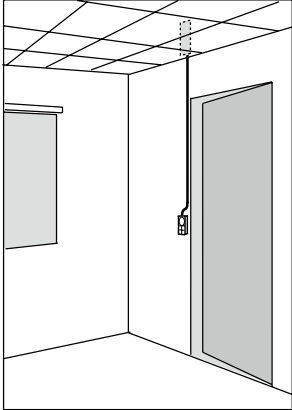

Control unit located above the ceiling. Connection via the bottom edge. Fitting it above the ceiling will not impede the RF communication.

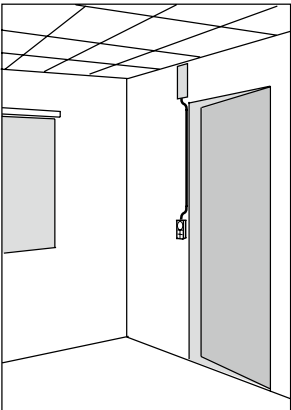

Control unit located above an existing connection box. Connection through the back or bottom edge.

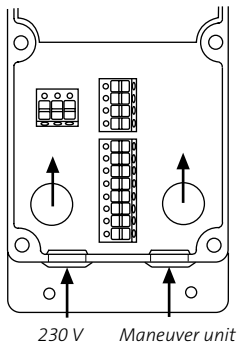

Cable entries on a control unit.

Connection of control unit and maneuver unit

The only physical wiring for e-Sense Connect is between the control unit and the maneuver unit. Depending on the functions selected, the number of conductors involved in the connection can vary from 4 to 12. The cabling is in the SELV category and extra-low voltage cable can be used.

The 86303 control cable is a pre-configured 3 meter cable ELQXB (6×2×0,5), approximately 9 mm in diameter.

Apart from the rotary potentiometer, other pushbutton functions can be connected in parallel. LED functions are not recommended for in-parallel connections. For reasons relating to functionality, rotary potentiometers cannot be connected in parallel.

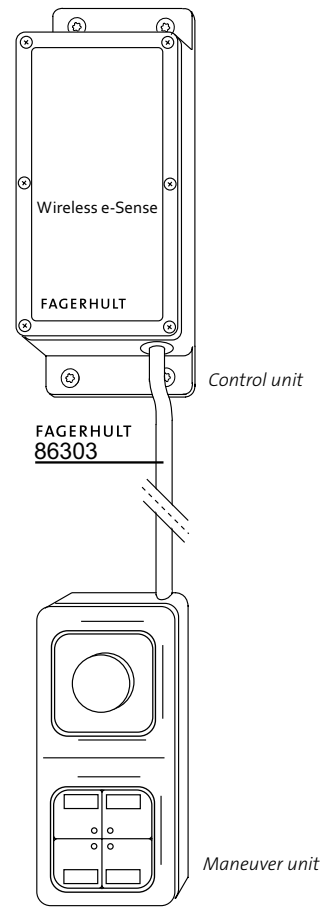

Pushbutton for board light connects to terminal 5.
LED indicator for board light connects to terminal 1.

Pushbutton for projector scenario connects to terminal 6.
LED indicator for project scenario connects to terminal 2.

Pushbutton for AUX function F connects to terminal 7.
LED indicator for AUX function F connects to terminal 3.

Pushbutton for AUX function G connects to terminal 8.
LED indicator for AUX function G connects to terminal 4.

- polarity for potentiometer connects to terminal 11.
+ polarity for potentiometer connects to terminal 10.

Pushbutton function in potentiometer connects to terminal 11 and 12.

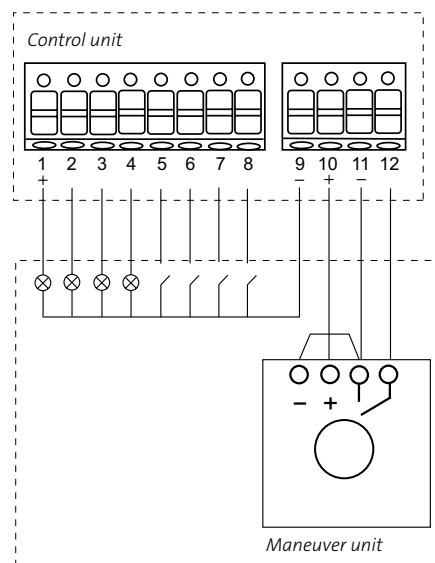

General connection diagram.

Interface for control with impulse switch

- Manual on/off – press the switch shortly.
- Dimming -Press the switch longer for dimming up or down. If light increases, release the switch and press again for dimming in opposite direction.

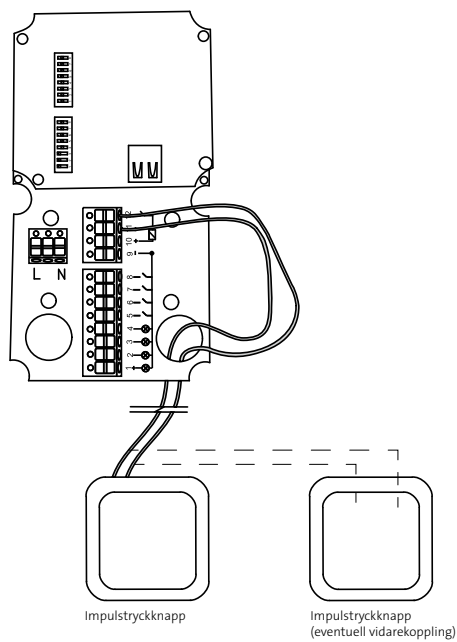

User functions

Operation of the various functions

The main ceiling lighting function is adjusted using a rotary potentiometer. This function is easily understood and is widely recognised. If the room does not contain any further lighting, this function is all that is needed. It works like a normal dimmer switch which you press for ON/OFF. Other control functions are connected via momentary pushbuttons.

Adjustment of ceiling lighting

A rotary potentiometer for control of 1–10 VDC – press for on/off. Potentiometers that have switch-off at the knob end-position must not be used. The potentiometer can be replaced with a impulse switch, see pages 10 and 25 for more information.

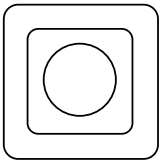

Adjustment of ceiling lighting and board lighting

For board lighting: A standard on/off switch of momentary type can be used.

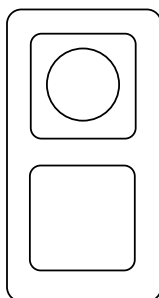

Adjustment of ceiling lighting, board lighting and projector mode

A standard dual on/off switch of momentary type can be used.

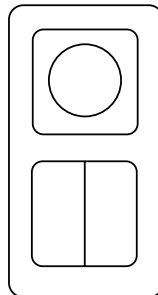

Adjustment of all available functions

Adjustment of ceiling lighting, board lighting, projector mode and two other functions, e.g., spotlight track or ventilation. Pushbuttons are equipped with LEDs which indicate whether the function is on or off – recommended for switch-on of ventilation, for instance.

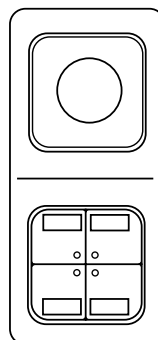

Operation of the various functions

The lighting in this installation is split into different groups, most of which are determined by how the lighting is fitted and the function it has. Other functions tend to be hidden and work automatically in the background or are accessed by pressing a button.

NB. The light does not come on automatically on entry into the teaching room.

Ceiling lighting (group A, B or C)

1. Press the knob.

The ceiling luminaires come on and the light is adjusted to the set daylight level (zone A, B and C daylight is adjusted individually).

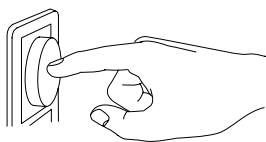

2. Turn the knob.

The light from the ceiling luminaires is adjusted according to the manual setting. The daylight function is stopped. Zone A, B and C are adjusted together.

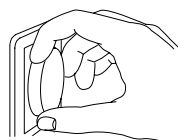

3. The light switches off automatically after 15 minutes if no further occupancy of the room is detected. It can also be switched off manually.

Interface for control with impulse switch replacing rotary potentiometer

Interface 86304 must be used (control units with FW-version 1.7 or later can be controlled without interface).

- Manual on/off and dimming. Parallel switches can be used.
- Manual on/off – press the switch shortly.
- Dimming -Press the switch longer for dimming up or down. If light increases, release the switch and press again for dimming in opposite direction.

Board lighting (group D), pushbutton 1

Press the button.

The board lighting comes on or goes out depending on the previous switch position. A LED can be used to indicate when the light is on. Switches off automatically once there is no more occupancy.

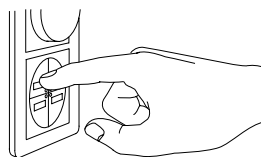

Projector mode (group E), pushbutton 2

Press the button.

Ceiling luminaires right at the front are adjusted down to ensure good contrast on the projection screen. The remaining ceiling luminaires can now be adjusted with the knob. Daylight control is stopped. Press once to return to the previous mode.

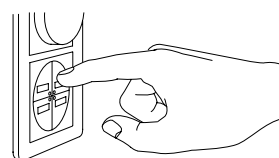

Pushbuttons 3 & 4 (groups F & G)

The remaining pushbuttons 3 and 4 can be used for similar functions, such as board lighting.

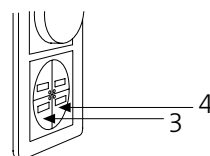

System functions – basic settings

Automatic or manual switch-on

The system is set up for manual switch-on. You can use the control unit to change this to automatic switch-on, which will be better suited to open-plan offices. Move DIP switch 1 to OFF on the control unit.

Automatic or manual switch-off

You can always switch off the ceiling lights manually by pressing the knob. Other functions, e.g., board lighting, are switched off at the respective pushbuttons. If the light is not switched off manually, it will be switched off automatically 15 minutes after the last movement is detected. Board lighting, etc., will then also be switched off, and the system is reset to the switched-off position. On the control unit you can deselect the occupancy detection function. In some installations, daylight control without occupancy detection is a better option. Move DIP-switch 1 to ON on the control unit.

Automatic daylight control

The system normally has automatic daylight control on switch-on, as this is the optimum energy-saving mode. If this function is not required in certain installations, the daylight control can be deselected on the control unit by moving DIP switch 3 to OFF.

Demostration mode

Change DIP-switch 4 temporarily to ON. Now it's possible to see the whole system working with presence detection and off-sequence. All delay times normally set in minutes are temporarily changed to seconds. For example, after last detected presence, it only takes the system 15 seconds to dim down and turn the light off. Re-set the DIP-switch to OFF for normal use.

Mute mode

DIP switch 5 in ON position: This will temporarily mute the control unit without turning the power off. This function is useful when a RF unit must be relocated to another control unit nearby. See page 29 for operation.

Dynamic Off time

The standard setting of the Off delay is set to 15 minutes after the last movement is detected. Once this time elapses the light begins to adjust down, alerting anyone in the room to imminent switch-off. If this is noticed before the light switches off and the sensors detect movement again, the Off time is doubled to 30 minutes. This doubling is only temporary.

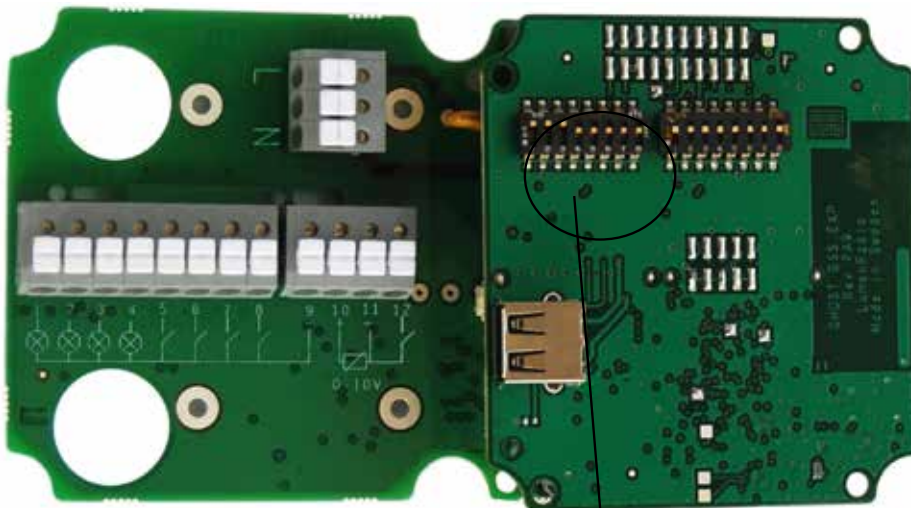

Setting basic functions on DIP switches.

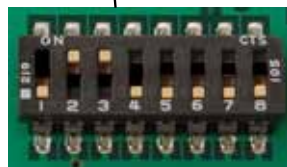

Default settings:

- DIP switch 1: Manual on.
- DIP switch 2: Automatic off.
- DIP switch 3: Dynamic constant light.
- DIP switch 4: Demonstration mode.
- All delay times in minutes are temporarily changed into seconds.
- DIP switch 5: Mute mode for reinstallation.
- DIP switch 6: Use of impulse switch.
- Other switches are without function in ver. 1.

Daylight control

The system is structured around 3 zones, each with its own daylight control of the lighting. This requires that there is at least one luminaire with a sensor in each of zones A, B and C. The zones are designed to be used as follows:

- A – Luminaires closest to windows.
- B – Luminaires in the centre of the room.
- C – Luminaires furthest away from windows.

During manual control, all the zones are adjusted together as one via the rotary potentiometer, but in daylight mode the light is adjusted on a more individual basis zone by zone. The incidence of light from the windows differs during the day and at different times of the year. Zone A can adjust more than the other zones, zone B more than zone C. This uses e-Sense Connect dynamically to provide even distribution of light and save energy. The system has additionally removed other functions which have made other systems less effective.

While other systems may switch off the lighting completely when there is a lot of daylight, e-Sense Connect does not do this. During daylight control, the light is only adjusted down to around 10%, which is on the energy-saving threshold. Below this percentage, adjustment to lower levels is more applicable for reasons of comfort, e.g., in conference rooms.

Other systems have daylight sensors that can affect one another, resulting in an unstable and constantly changing light level. e-Sense Connect features an algorithm function which compares the values from the three zones to maintain the correct value throughout the entire room. If one zone reads extremely high light levels (e.g., reflected sunbeams or the sun's reflection), this counteracts reduction of the light based on the value from the sensors in the other zones. So energy saving is optimised without sacrificing the quality of light.

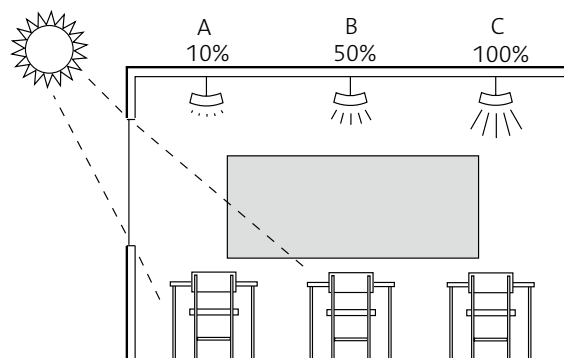

If incident daylight illuminates the room unequally, the darker zones are compensated using a greater amount of artificial light.

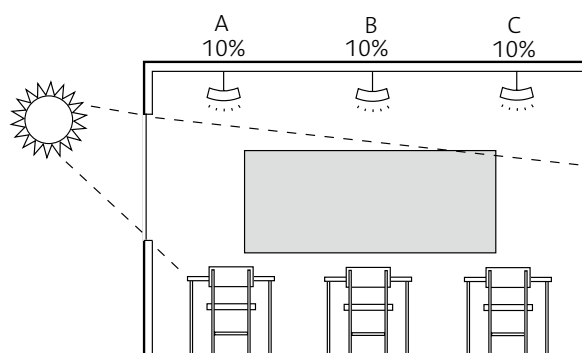

When distribution of daylight in the room is more even, the various zones tend to be adjusted more as one.

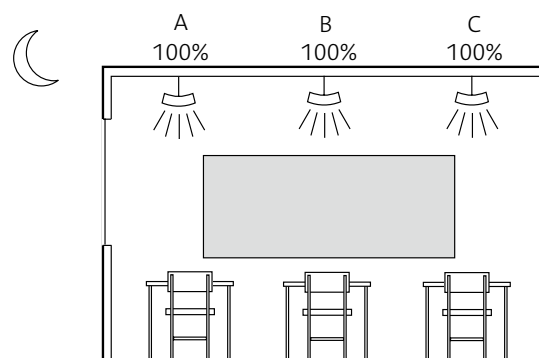

In the absence of daylight, it is the set lux value that controls the light level.

Occupancy detection – PIR function in sensor

Sensor for occupancy detection

The sensor has a PIR (Passive InfraRed) module which detects infrared light in motion, or, to put it more simply, a warm body in motion. Information from the detection system is supplemented by a time delay so that periods of non-detection (e.g., sitting still) do not adversely affect the system, by switching off the light, for example.

Multiple PIR sensors in the system

In a room where there are many luminaires, more than one of these will need sensors for occupancy detection. The sensors communicate over the network and send a joint signal if there is occupancy. Only once all sensors have stopped detecting occupancy does countdown of the time delay begin. Any movement resets the time. If the light goes out, it has to be switched on manually.

Unintended switch-off during occupancy

If you are sitting in a zone which has poor detection, or if objects impede detection, the light will begin to adjust down once the time delay has elapsed. If you then make a movement in the detection range, the lighting will return to its original value and the time to switch-off will be doubled temporarily. This dynamic occupancy detection ensures there are no undesirable consequences when few people are present in the room.

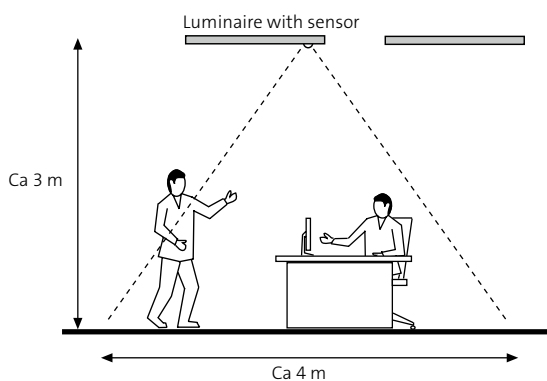

Example of detection range.
Luminaire located approximately 3 metres high detects occupancy over a range slightly more than 4 metres in diameter.

Projector scenario (group E)

Computers and other electronic teaching aids, are increasingly commonplace in teaching rooms, but a particular technological aid is a ceiling-mounted video projector for other using slideshows and teaching programs. The communication is more effective if you can obtain a good picture, with good contrast and colour. A common scenario is where a luminaire, located in the best position to light the room, instead illuminates the projection screen or some other surface used for projection of the image. e-Sense Connect has a unique function called “projector scenario”. Using this scenario, you program in those luminaires which are to be dimmed when a projector is used. Daylight control is temporarily over-ridden, and other luminaires can be adjusted to a suitable level using the knob.

Press button 2 to activate project scenario. Luminaires programmed for projector scenario are adjusted down to approximately 10 %, and the other luminaires can still be adjusted via the knob. If you want to adjust the light down to below 10 %, then those luminaires that are at 10 % will also be included. If you want to exit the projector scenario, press the same button again (button 2). The light returns to its previous mode.

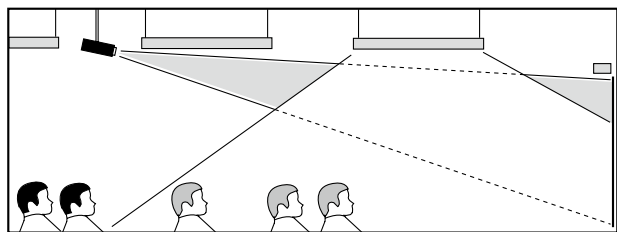

Luminaires near to the projection surface cannot be adjusted separately. Incident light interferes significantly with the projected image. The only other option is to switch off all ceiling lighting, although this is not the best approach.

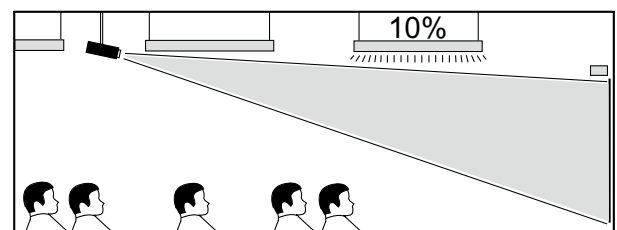

With projector scenario activated, you get a combination of good picture contrast and light in the room. The light level can be adjusted manually using the rotary potentiometer.

System programming

Link between RF remote control and control unit

The first thing that you need to do when programming a system is pair the RF remote control with the correct control unit. There may be several control units nearby, so this is Step 1. Follow the instructions below. The rotary potentiometer must be connected and the control unit powered up.

1. RF remote control

- Make sure that the battery circuit is activated (switch in position UP)
- Press and hold down “SYSTEM CONNECT ON”.

NOTE! Make sure that the battery circuit is connected. ON = Switch in position UP.

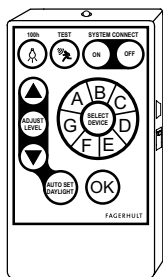

2. Turn the potentiometer.

(or press the impulse switch if such is used).

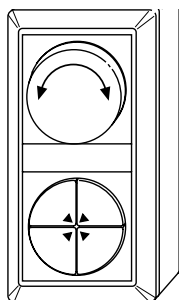

3. BEEP!

This signal means that the RF remote control and the control unit are communicating with one another. Potentiometer and pushbuttons are locked during programming mode.

4. You can disconnect from a control unit by pressing “SYSTEM CONNECT OFF”. A beep from the control unit confirms this.

NOTE! After “SYSTEM CONNECT OFF”, the system will go into normal user mode by turning the light off for a couple of seconds. After this, the system is ready to use.

After ending programming, disconnect the battery circuit on the remote control by turning the switch to OFF (switch in position DOWN).

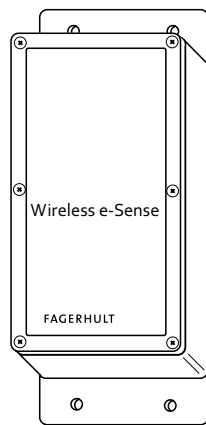

Connection and grouping of luminaires to systems

The following actions will only work if the steps outlined on page 15 have been performed correctly.

1. Direct the RF remote control at the luminaire that you want to program and press "SELECT DEVICE" shortly. Aim thoroughly against the luminaire's light source! Keep aiming the RF remote control until the light source dims down, and stays dimmed.

NOTE! Other luminaires that also detects the search sequence can dim down one by one, wait until the luminaire you want to program dims down. If not, repeat 1.

2. Now you can select which group(s) it is to belong to (you do not need to aim against the luminaire anymore, the communication is between the RF remote and the control unit).

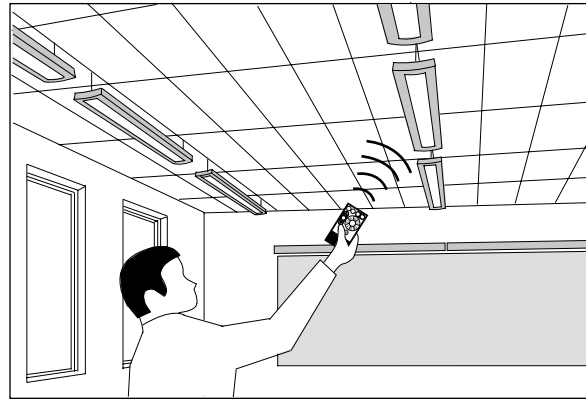

Direct the RF remote control at the luminaire as accurately as you can during Step 1. You can always reconfigure a luminaire. Repeat the process Step 1 and 2. The previous programming is deleted.

- A
- or B
- or C
- or D
- and E Projector scenario
- or F
- or G

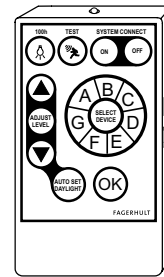

Always finish programming by pressing AUTO SET DAYLIGHT. The system will then configure all features, including the occupancy sensors.

Finished!

Identification of group membership

To get a view over how RF-units are programmed, it is possible to identify all grouped units by selecting A–G on the RF-transmitter.

1. Press (for example) button B on the RF-transmitter. The transmitter doesn't have to be aimed at any luminaire.
2. Luminaires grouped in B will now dim down to a low level. Non dimmable light sources in the same group will turn off. All other units in the system will dim to 100 %.
3. It is now possible to overview another group with button A-G on the transmitter.
4. Go back to normal function by pressing OK button.

Automatic setting of daylight control

The following actions will only work if the steps outlined on page 15 have been performed correctly.

Requirements for automatic setting. A luminaire/luminaires with a sensor work best if they are configured together with the auto function of the system. This ensures the best operation and light from combined use of the various groups. Any effects of sunlight in this situation should be avoided. Cover the windows so that the effect of sunlight is reduced as much as possible.

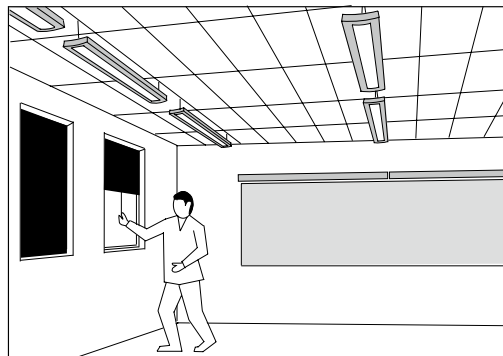

Avoid any effects of sunlight when making the auto setting.

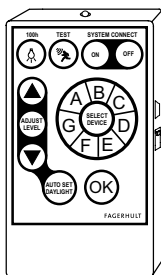

1. Press "AUTO SET DAYLIGHT". The luminaires will now adjust in accordance with a predetermined pattern. The sequence might take a couple of minutes. The sequence is automatically terminated by the light controlling to 100 %. The new set level is valid after pressing "SYSTEM CONNECT OFF" on the RF remote (light turns off and then

on to the new level).

NOTE! The "Auto set daylight" sequence must be done even if daylight control is not used. This is for calibrate other functions in the sensors.



The control unit beeps continuously once a second to indicate that the calibration sequence is active.

2. If you prefer a light level that is different from the target value, you can easily adjust it. Press "ADJUST LEVEL".



The control unit beep once to indicate that the function is activated.

3. Now you can adjust the light level to the desired value using the ▲ and ▼ function. Use a lux meter to set the desired value.



The control unit beeps shortly at every adjustment to indicate that the light level is changed.

4. Press "OK" to finish. This saves the set light level as a new target value and repeats the calibration sequence referred to in point 1.



The control unit beeps continuously once a second to indicate that the calibration sequence is active.

Always finish programming by pressing AUTO SET DAYLIGHT. The system will then configure all features, including the occupancy sensors.

Burn in of light sources

The following actions will only work if the steps outlined on page 15 have been performed correctly.

Fluorescent lamps and compact light sources. The aforementioned light sources will work right away in terms of light adjustment, but you can ensure this function also works at very low levels by first “seasoning” or “burning in” the lighting for 100 hours. This results in all gases being mixed properly within the fluorescent lamp. The sequence is terminated automatically.

Tip: start 100 h, and let it run over the weekend. Over the period from Friday to Monday, the system can season the fluorescent lamps for around 70 hours, which, according to most manufacturers of fluorescent lamps, is quite sufficient. If the function is used during the working day, you can also make good use of the light, but, given that all control functions will be inoperable, others may well perceive the system as being out of order. The sequence is aborted by pressing the 100 h button again.

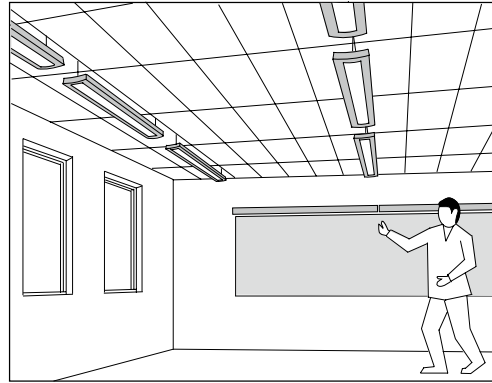

During the 100 h sequence you will not be able to adjust the light.

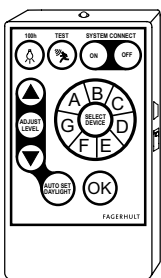

1. Press “100 h” and thereafter “SYSTEM CONNECT OFF” (light turns off and then on to 100 %). All manual functions are now locked. The sequence is terminated automatically by the light switching off.

2. To stop the sequence earlier than 100 hours, do the same programming procedure again. Follow instruction on page 24 first.



The control unit beep once to indicate the activation or deactivation of the sequence.

Test of occupancy detection

The following actions will only work if the steps outlined on page 15 have been performed correctly.

To check and adjust the occupancy detection in the room, you can put the system into a test mode. In this test mode, the system will control all luminaires to 10 %, that detect occupancy, whereas luminaires that do not detect occupancy will illuminate to 100 %. This means that you can move around the room and get an idea of which zones are covered by occupancy detection.

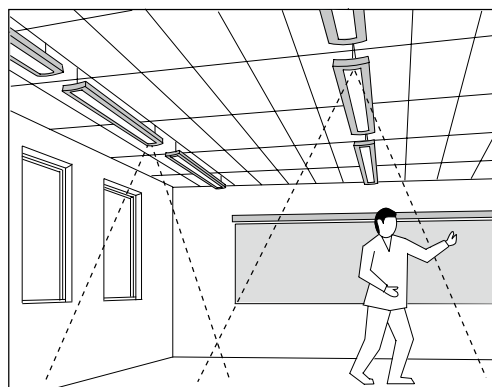

Movement will activate luminaires with sensors to dim down.

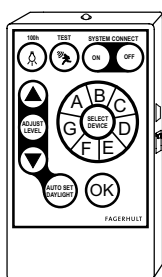

1. Press "TEST".

By moving around in the room you will get an idea of the detection range.

2. If you want to exit the enabled function, press the TEST button again, and thereafter "SYSTEM CONNECT OFF".



The control unit beep once to indicate the activation or deactivation of the sequence.

System programming

Moving a luminaire to another system

Change of location

A luminaire with an RF unit which has already been programmed for communication with a control unit can be moved to another installation. The important thing is that the original control unit must lose contact with the RF unit, so that it can be reprogrammed. If the control units are placed near to each other, this will be extremely important if reprogramming is to be successful. Reprogramming can be performed in two ways:

Switching off the original control unit

The luminaire can be moved and reprogrammed once the original control unit has been switched off.

- Switch off the power to the original control unit, or set switch 5 in MUTE mode ON.
- Move the luminaire to the new installation.
- Program as usual as per the information given earlier.
- Reset the original control unit.

Resetting an RF unit

The RF unit can be reset to its factory settings. This requires that you access the RF unit in the luminaire. Resetting like this requires the luminaire to be partially dismantled and connected to the mains voltage. It must therefore be carried out by a qualified installation engineer. Resetting is performed with a so-called re-set plug. Please contact Fagerhult for further information and details.

- Switch off the power to the luminaire in question.
- Dismantle or open the luminaire to access the RF unit.
- Disconnect any sensor from the RJ11 connection.
- Insert the re-set plug in the RJ11 connection. Switch on the power to the luminaire.
- After 10 seconds the RF unit is reset to its factory settings.
- Dismantle the luminaire and move it to the new installation.
- Program as usual as per the information given earlier.

User functions

Maneuver unit, examples of various maneuver unit options from different countries:

ELJO (SWEDEN)

	Cat. no.
Rotary potentiometer	E 19 015 18
Single pole momentary pushbutton	E 18 301 22
Two-way momentary pushbutton	E 18 301 07
Spring for impulse function	E 18 305 22
Four pole pushbutton, extra-low voltage with LED indicator	E 18 314 17
Frame for two devices	E 18 307 37
Box for surface mounting, two devices	E 18 307 99

Various combinations can be used for optimal use.

STRÖMFORS Artic (FINLAND) Type

	Type	Cat. no.
Kiertopotentometri APE10T		SSTL 35 124 77
Painonappi 1-osainen	1T-vipupainike	SSTL 21 011 01
1-os. pienjännitepainike	1-os. pienjännitepainike	SSTL 70 612 01
2-os. pienjännitepainike	2-os. pienjännitepainike	SSTL 70 612 02
4-os. pienjännitepainike	4-os. pienjännitepainike	SSTL 70 612 04
2-aukkoinen kehys	2-kehys	SSTL 21 607 12
2-yleispintarasia 38 mm	2-yleispintarasia 38 mm	SSTL 24 003 06

OPUS 66 (DENMARK)

	Cat. no.
Rotary Potentiometer, Grey	1067004336
Double Frame, Grey	1017033904
Pushbutton, 4 functions with LEDs	1092001003
Twin pushbutton	1017023030
Spring for impulse function	1017026940
Double box for surface mounting	1017033713

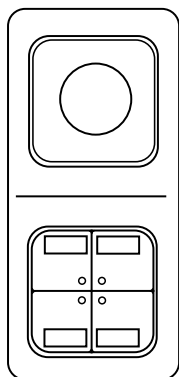

e-Sense Connect RF unit used as a relay

The RF unit contains an integrated relay for a 2 A resistive load, which is equivalent to 2 HF ballasts of various makes. When loading with HF ballasts, it is the in-rush current which needs to be taken into account. The relay is also used for switch-off in DALI communication to the HF-ballasts; the RF-unit has much lower standby current (0.01 W) and is therefore advantageous for long periods where the lighting is off. The relay can be used to control other loads, e.g., non-dimmable HF ballasts as in board lighting, or another light source.

Note: If several RF units are to control functions via relay: On a RF unit which is used for relay control of a load other than a light source, the DALI connection must be bridged (shorted).

When programming an RF unit for relay control it is important that only one RF unit may be powered up at a time during the programming phase.

Since there is no light source that accepts the grouping command, you need to proceed in this way to ensure you know which unit is being programmed.

In the case of loads that are larger than the above, an external load relay must be used. To prevent interference, the relay/contactor should be equipped with an interference suppression circuit (RC component). On/Off functions can be used in group D (normal board lighting On/Off) and groups F and G. Buttons for the corresponding functions act as momentary pushbuttons and are reset once the system switches off (e.g., On – board lighting goes out). External functions for projection screen, ventilation, motorised curtains, blinds or similar may only be used if the function is supported in the relevant external control unit.

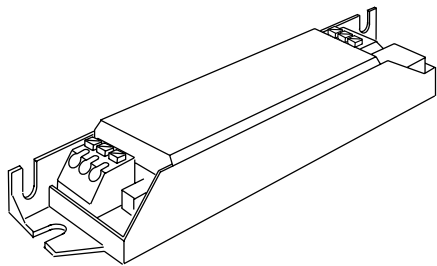

230 V relay output at terminal L.



Setting DALI when used as a relay without a light source. If the RF unit is used, for example, for a whiteboard light, the DALI terminals shall not be short circuited.

Technical information

e-Sense Connect RF unit

Supply

- 220–240 VAC
- Max 1.5 W/0.01 A.
- Short-circuit protected with self-healing fuse.

Wireless performance

- Frequency range: 2402–2480 MHz.
- Maximum output power: 40 mW.
- Modulation method: GFSK.
- Range without line of sight: up to 30 m.
- Range with line of sight: up to 100 m.

Performance for DALI connection and relay

- Maximum of 4 DALI loads can be connected.
- Relay breaking capacity: maximum of 2 A resistive load.
- Supply from relay: 220–240 VAC.



RF unit.

e-Sense Connect control unit

Supply

- 220–240 VAC
- Max 2 W/0.02 A.
- Short-circuit protected with self-healing fuse.

Wireless performance

- Frequency range: 2402–2480 MHz.
- Maximum output power: 40 mW.
- Modulation method: GFSK.
- Range without line of sight: up to 30 m.
- Range with line of sight: up to 100 m.

Performance for connections for maneuver unit

- All connections are short-circuit and transient protected.
- 1–10 V connection for potentiometer.
- 15 V signal for switch.
- 15 V supply to pushbuttons.
- 15 V supply for LED indicators.

Physical characteristics

- Dimensions: L×B×H = 197,5×92×47,5 mm.
- Type of plastic: ABS.

CE marking

- The product meets the requirements for CE marking under EN 300 328, EN 301 489-17 and EN 61347.



Control unit.

e-Sense Connect remote control

Supply

- 2×AAA batteries.
- Connecting or disconnecting of the battery power is done with a switch located on the right side of the RF remote. When the RF remote is not used, always disconnect the battery circuit.

Wireless performance

- Frequency range: 2402–2480 MHz.
- Maximum output power: 1 mW.
- Modulation method: GFSK.
- Range without line of sight: up to 3 m.
- Range with line of sight: up to 10 m.

Physical characteristics

- Dimensions: L×B×H = 105×58×19 mm.
- Type of plastic: ABS.

CE marking

- The product meets the requirements for CE marking under EN 300 328 and EN 301 489-17.



Remote control.

Special functions

Software, updates to control unit via USB

You can identify the control unit software from a label in the unit, containing, e.g., the words "ver. 1.0".

Updating of an e-Sense Connect system is performed in the control unit and by connecting a USB memory stick. For further information or updates please contact Fagerhult.

NOTE! Mains voltage must be disconnected to the Control unit before assembly.

Connection between remote control and PC for future use and programming USB connection on remote control

The remote control has a connection for mini-USB which can be used for programming and updates in the course of any future system development. The remote control then works as a communication link between the control unit and the software. You must still link up the remote control with the local control unit.

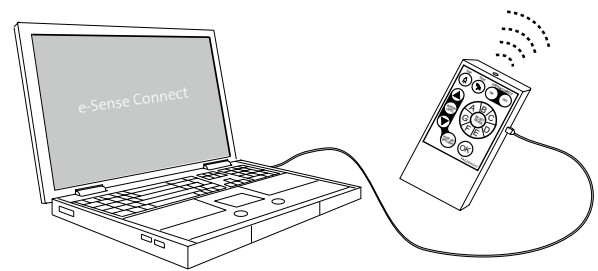
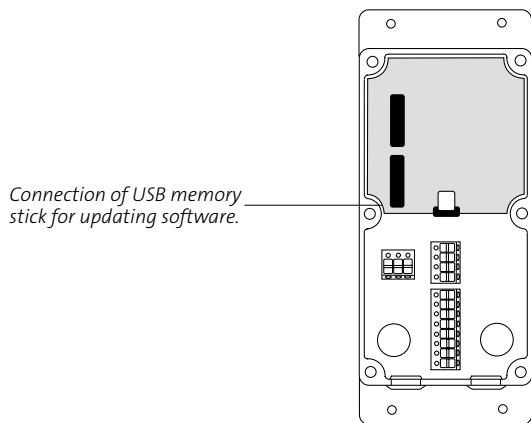

FAGERHULTS BELYSNING SVERIGE AB

HEAD OFFICE

SE-566 80 Habo

Tel +46 (0)36 10 85 00

Fax +46 (0)36 10 86 99

info@fagerhult.se

www.fagerhult.se